

TO BE THE WORLD'S LEADING  
HIGH-END EQUIPMENT AND SMART  
MANUFACTURING SOLUTION  
PROVIDER



SHEET METAL FORMING MACHINE

LASER PROCESSING EQUIPMENT

INTELLIGENT MANUFACTURING SOLUTION

## Mission—

Satisfy the customers, accomplish the employees, repay the shareholders and benefit the society

## Vision—

To be the world's leading high-end equipment and smart manufacturing solution provider

## Value—

People-oriented, sustainable innovation, diligent and working hard for the prosperity, sincerity and honesty for win-win cooperation

誠  
精  
和  
新

- Honest: Take honesty, sincerity as root
- Excelsior: Always seek for the better
- Harmonious: Be harmonious and work together with all one's heart
- Innovative: Always focus on innovation



# CONTENTS

## 04 COMPANY PROFILE

- 04 COMPANY INTRODUCTION
- 05 HISTORIC MILESTONES
- 06 TECHNOLOGY INNOVATION
- 08 PRECISE MANUFACTURING
- 10 MARKETING&SERVICE
- 11 INTERNATIONAL COOPERATION

## 12 METAL FORMING MACHINE

- 14 CNC TURRET PUNCH
- 16 CNC PUNCH COMBI MACHINE
- 18 CNC PUNCH CELL
- 20 CNC PUNCH SHEAR COMBI CELL
- 22 CNC PRESS BRAKE
- 24 CNC BENDING CELL
- 26 CNC PANEL BENDER
- 28 AUTOMATIC SHEET METAL PROCESSING SYSTEM
- 32 CUT TO LENGTH LINE,SLITTING LINE
- 34 BLANKING LINE, CUTTING TO LENGTH LINE WITH OSCILLATING SHEAR
- 36 ALUMINUM SHEET PROCESSING LINE

## 38 LASER PROCESSING EQUIPMENT

- 40 2D CNC LASER CUTTING MACHINE
- 42 3D CNC LASER CUTTING MACHINE
- 44 LASER CUTTING CELL / SYSTEM
- 46 CNC LASER TUBE CUTTING MACHINE
- 48 LASER WELDING EQUIPMENT

## 50 INTELLIGENT MANUFACTURING SOLUTION

- 52 INDUSTRIAL ROBOT
- 54 WAREHOUSE LOGISTICS AUTOMATION SYSTEM
- 56 INDUSTRIAL MANAGEMENT SOFTWARE
- 58 SaaS PLATFORM
- 60 INDUSTRIAL BIG DATA PLATFORM
- 62 DIGITALIZED FACTORY PLANNING
- 64 INTELLIGENT MANUFACTURING LINE

## 66 FUTURE DEVELOPMENT

# COMPANY INTRODUCTION

## Jiangsu Yawei Machine Tool Co., Ltd.

Jiangsu Yawei Machine Tool Co., Ltd. (Abbreviated as Yawei, stock code 002559) is a well-known supplier of high-end equipment and intelligent manufacturing solutions. Founded in 1956, it is located in Yangzhou City, Jiangsu Province. In 2011, it was listed on the SME Board of Shenzhen Stock Exchange market, Yawei provides sheet metal forming machines, laser processing equipment, industrial robots, automatic production lines, factory management software, and intelligent workshops for well-known companies in the automotive, transportation, aviation, sheet metal, power and electrical, elevators, and home appliances industries. At present, the company has total assets of 2.3 billion, net assets of 1.6 billion, covers an area of 400,000 M<sup>2</sup>, more than 1,500 employees, 42 domestic sales and service offices, and sales agent network in more than 40 countries.

After more than 60 years of development, Yawei shares have formed a good situation that three major businesses develop in a collaborated way:

Sheet metal forming machines grow steadily and stay at the forefront;

Laser processing equipment continues to erupt and grow rapidly;

Intelligent manufacturing has doubled and accelerated growth.

In the future, Yawei will focus on the discrete manufacturing industry and create a new leader in intelligent manufacturing!

### Sheet Metal Forming Machine

The main products include CNC turret punch, CNC press brake, CNC shears, coiling machines and matched automatic production lines. As a leading enterprise in the industry, the competitive advantage is obvious. Among them, CNC press brake, CNC turret punch and coiling machines have ranked first in China.

### Laser Intelligent Equipment

The main products include mid and high power fiber laser cutting machines, 3D laser cutting and welding and additive manufacturing systems (including 3D printing), and laser automation production lines. Yawei laser products enjoy a high reputation both at home and abroad due to their high cutting quality and high efficiency. At present, Yawei has the production capacity of producing more than 1,000 sets of high-quality laser processing equipment and automation systems annually, which can effectively support the sustained and rapid growth of the laser business in the future.

### Intelligent Manufacturing Solution

Yawei is positioned as the new leader in intelligent manufacturing in discrete manufacturing industries. It addresses the challenges of discrete manufacturing industry in implementing smart manufacturing and provides customers with five categories of products and services at different levels, including intelligent equipment, flexible processing units, automated production lines, production management systems, smart factories, and services. In the key industries such as sheet metal processing, automotive parts, power electricity, elevators, and home appliances, we provide intelligent manufacturing system solutions with "hardware + software + cloud computing + system integration + consulting and planning" for customer transformation and upgrading.

## 2014

Collaborated with Reis, Germany and established a industrial robot joint venture company

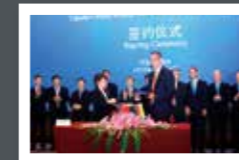

## 2001

Went abroad to cooperate with international advanced technology companies (Switzerland, Japan)



## 1956

Yawei predecessor, "Jiangdu Shaobo Chengchang Iron Factory" was established



## 2017

Yawei upgraded "Intelligent Creation" again and a new 1 billion industrial fund has been established



## 2011

Yawei successfully listed



## 1976

Yawei began to produce the low beam up bending machine and entered the forging machine industry



# HISTORIC MILESTONES

# TECHNOLOGY INNOVATION

## Leading technological innovation capabilities

Host or participate in **5** national and industry standards

Undertake **8** major scientific research projects at or above the provincial level

**4** new products were identified as the province's first major sets of equipment.

**36** new products have been identified as high-tech products above provincial level

Received **5** provincial or higher scientific and technological progress awards, **180** various types of patents, including **25** patents for invention, and **10** software copyright



Yawei always adheres to the technologically advanced development strategy and continuously increases the R&D investment and R&D talent team building. The total R&D investment in 2017 was 83.71 million yuan, increased by 24% year-on-year. Now Yawei has a national postdoctoral scientific research station, a provincial-level technology center, and a key laboratory for Intelligent metal sheet equipment. It has set up R&D branches in Italy and Nanjing, accelerating the accumulation of high-quality R&D talents, and currently R&D talents occupy 22% of working staff, which leading in the industry.

- National Postdoctoral Research Station
- Jiangsu Provincial Technical Center
- Jiangsu Provincial Key Enterprise Laboratory
- Jiangsu Provincial Engineering Center

**01**  
Strong product development system

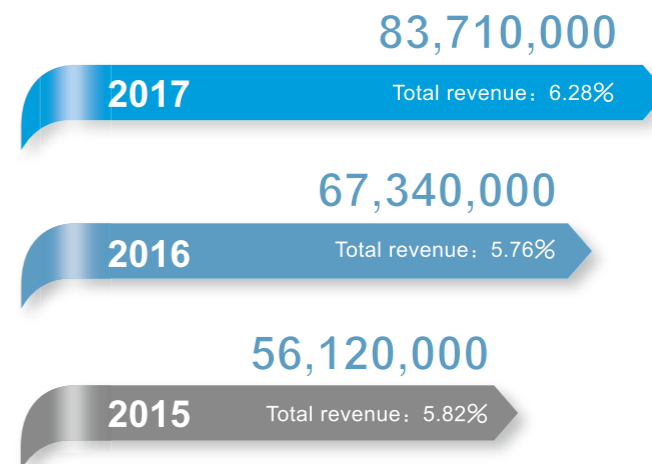

**02**  
Continuous high level of R&D investment

# PRECISE MANUFACTURING

## Equipment & Manufacturing

Sophisticated equipment and professional manufacturing offer a strong support for scale growth and quality control of Yawei's high-tech production. Now Yawei has four professional assembling and testing workshops and one precise manufacturing workshop. Also over 300 sets of imported equipments, such as CNC 5-axis machining center, CNC gantry machining center, CNC boring and milling machining center.



CNC horizontal machining center



CNC gantry machining center



Vertical machining center



CNC boring and milling machining center

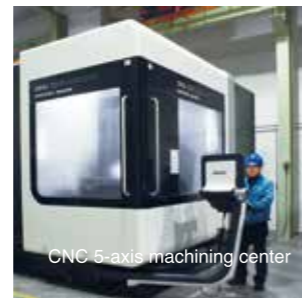

CNC 5-axis machining center



CNC boring and milling machining center

## Start from every trivial/complete every detail

The quality control system with the guideline "keep improving, try to be perfect, pursue customer's satisfaction".



# MARKETING & SERVICE

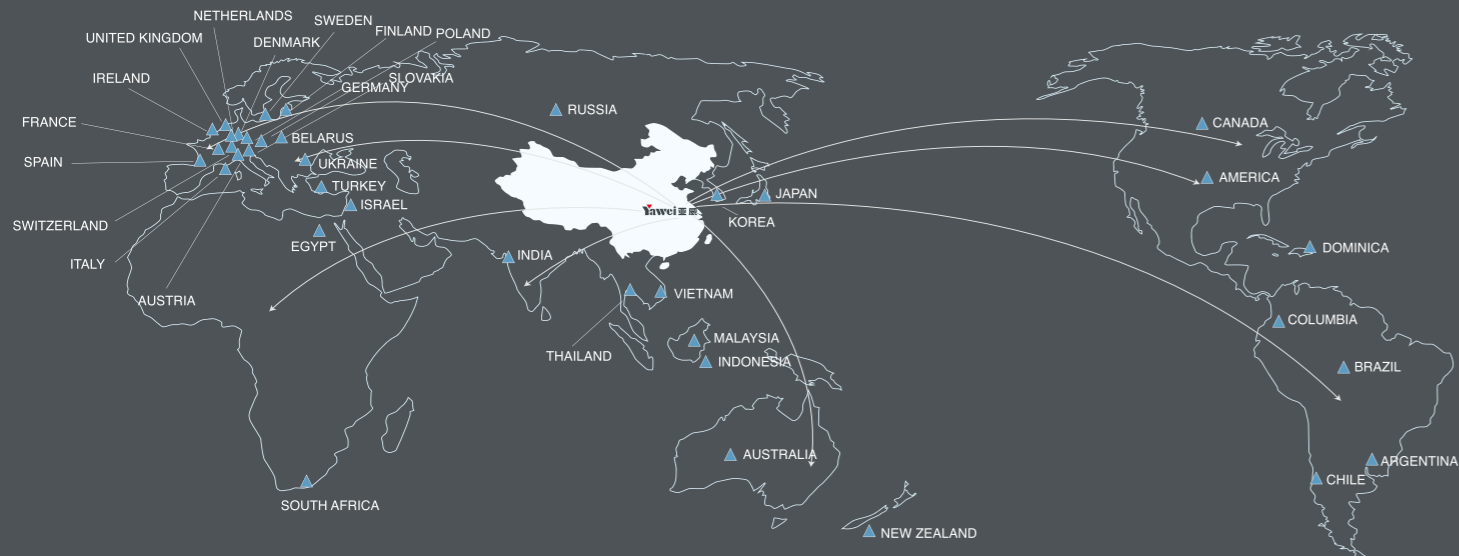

## Perfect sales network and service system

Established 42 domestic sales and service offices in China, and sales agencies in over 40 foreign countries

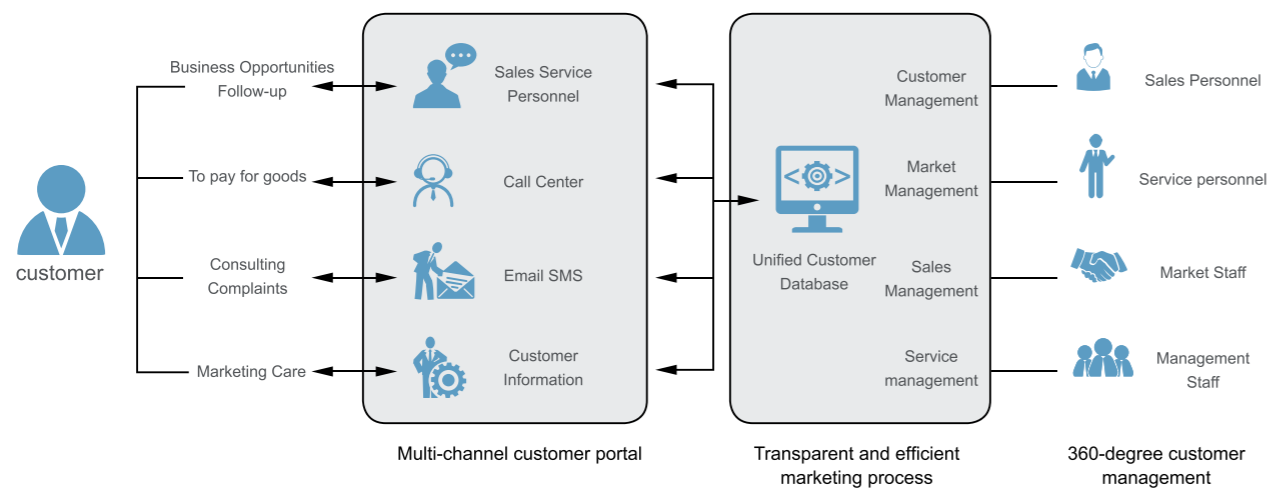

In order to serve more than 30,000 customers, we have established a complete customer service support system, provide a variety of product solutions and rapid technical services to ensure a good experience

## In 2002, Sino-Italy Jiangsu Yawei-Selema coil line processing Co., Ltd is invested by Yawei and Selema Italy, specializes in producing CNC aluminium coil line processing machines

Yawei-Selema has a high-quality technician team of over 10 years' experience and skill.

Sino-Italy Jiangsu Yawei-Selema coil line processing Co., Ltd is a joint venture company with advanced technology, high precision manufacturing, localization services.

Yawei-Selema has R & D centers in both China and Italy over 50 designers specializes in developing & producing CNC aluminium coil line processing machines.



## In 2003 Yawei carried out technical cooperation with Nisshinbo Japan's, introducing CNC turret punch technology and lean production management system

From Nisshinbo, YAWEI imported the full set of turret punch technology and process, learned the idea and method of lean production management from Nisshinbo, achieved a leap-forward improvement in the technical quality level of CNC turret punch press products, and at the same time it played a positive role in improving the production and management level of various products of Yawei.



## In 2014 Yawei cooperated with Reis from KUKA, entering robotics market

Yawei and Reis Germany successfully held the joint-ventures and licensing cooperation project in Yangzhou.

The partner Reis has a long history in robotics research and manufacturing and its share holder KUKA is among the world's top 4 brands in robotics industry which provides robots and flexible production systems for major industries.



# INTERNATIONAL COOPERATION

## METAL FORMING MACHINE

CNC TURRET PUNCH

CNC PUNCH COMBI MACHINE

CNC PUNCH CELL

CNC PUNCH SHEAR COMBI CELL

CNC PRESS BRAKE

CNC BENDING CELL

CNC PANEL BENDER

AUTOMATIC SHEET METAL PROCESSING SYSTEM

CUT TO LENGTH LINE, SLITTING LINE

BLANKING LINE, CUTTING TO LENGTH LINE  
WITH OSCILLATING SHEAR

ALUMINUM SHEET PROCESSING LINE

# ⚙️ CNC TURRET PUNCH

## Specialized for sheet metal punching and forming

With the main technology and components provided by NISSHINBO, Yawei manufactures the world's first class CNC turret punch machines, serving all sorts of sheet metal processing industries with a wide range of high-end customers.

Since 1998 the introduction of the first CNC turret punch machine, Yawei has accumulated successful experience of nearly 5000 sets machines, over the years Yawei focuses on innovative research and development, being able to provide a variety of mature products and features for customers, to provide you with best punching and forming process solutions.



HPE Series CNC Turret Punch



HPA Series CNC Turret Punch



HPM Series CNC Turret Punch

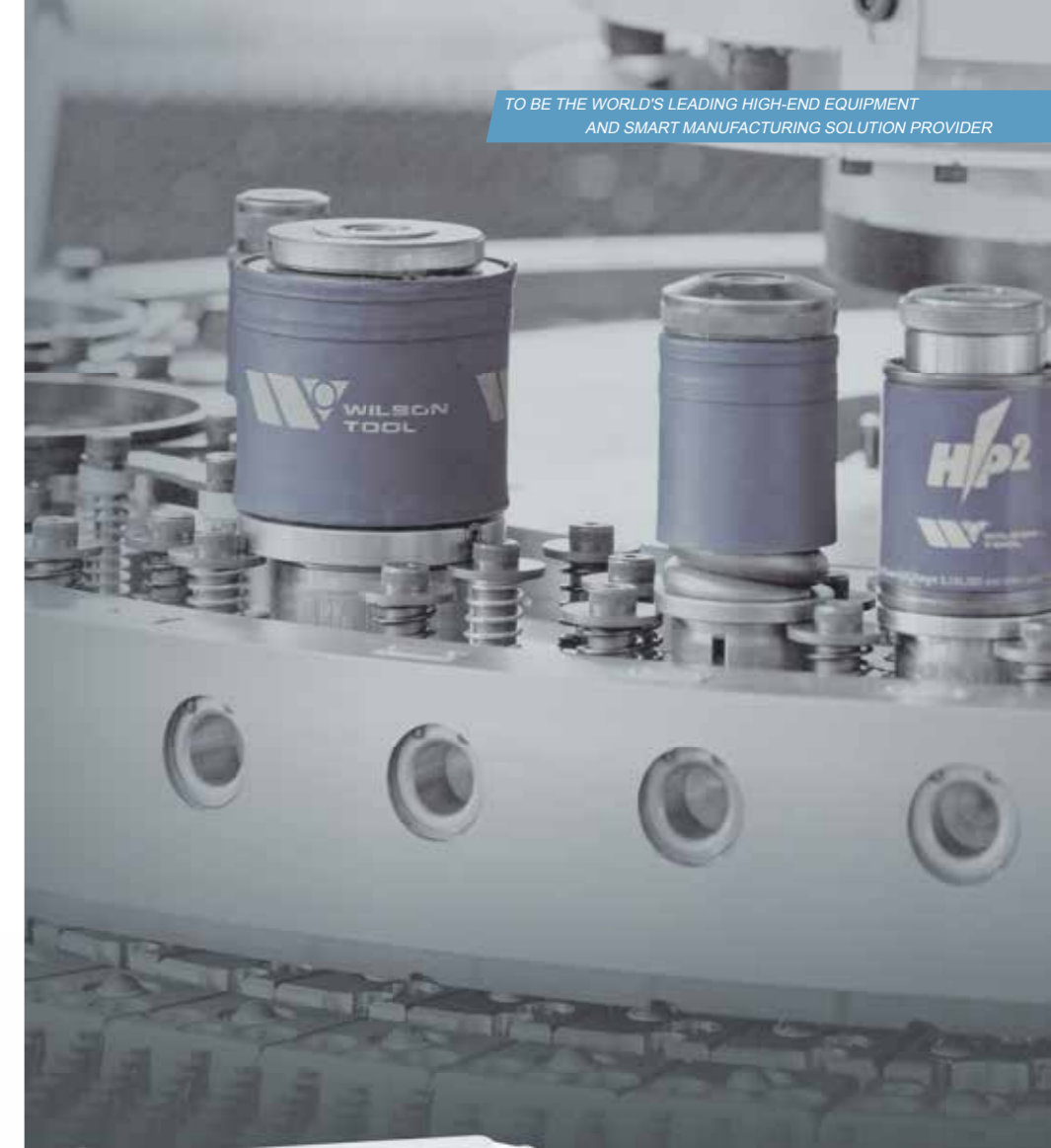



## CNC PUNCH COMBI MACHINE



HPES Series CNC Punch&Shear Combination

### Combine processing equipment for sheet metal punching and cutting

The CNC punch and shear combi machine combines the technical advantages of punching and right angle shearing, and can realize punching and threading. It can realize the nesting of large-format metal plates and improve the plate utilization rate and production efficiency; Right-angle shear can greatly improve the workpiece shear kerf quality and the vertical accuracy of the two right-angled edges.



### Combine processing equipment for sheet metal punching and laser cutting

The CNC punching and cutting machine combines the technical advantages of punching and laser cutting. It can realize punching, threading and smooth cutting. Not only can meet the high-precision mass production, but also can meet the flexible production of small pieces of a single batch.



HPML Series CNC punching and cutting combination

## CNC PUNCH CELL

### Special automation unit for sheet metal punching

The CNC press processing unit integrates the press processing, feeding and discharging devices, which can automatically complete the punching and stacking of metal sheets. The advanced control system effectively integrates all the functional units so that the efficiency of sheet metal processing can be upgraded to a new level.



Single side punching unit

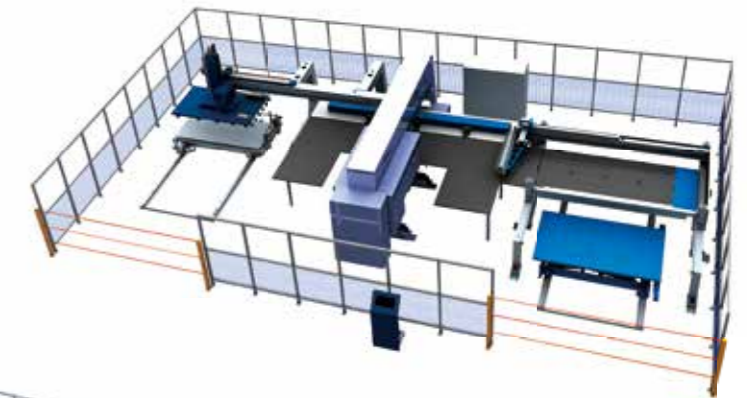

Double-side punching processing unit

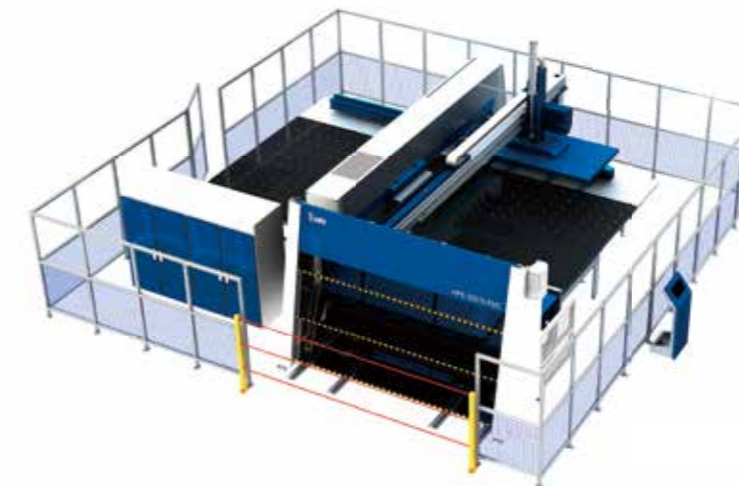

Single side compact punching unit

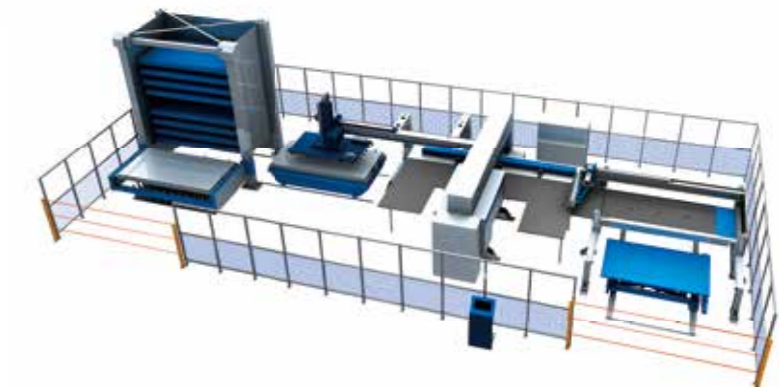

Double-side punching processing unit (with material library)



# CNC PUNCH SHEAR COMBI CELL

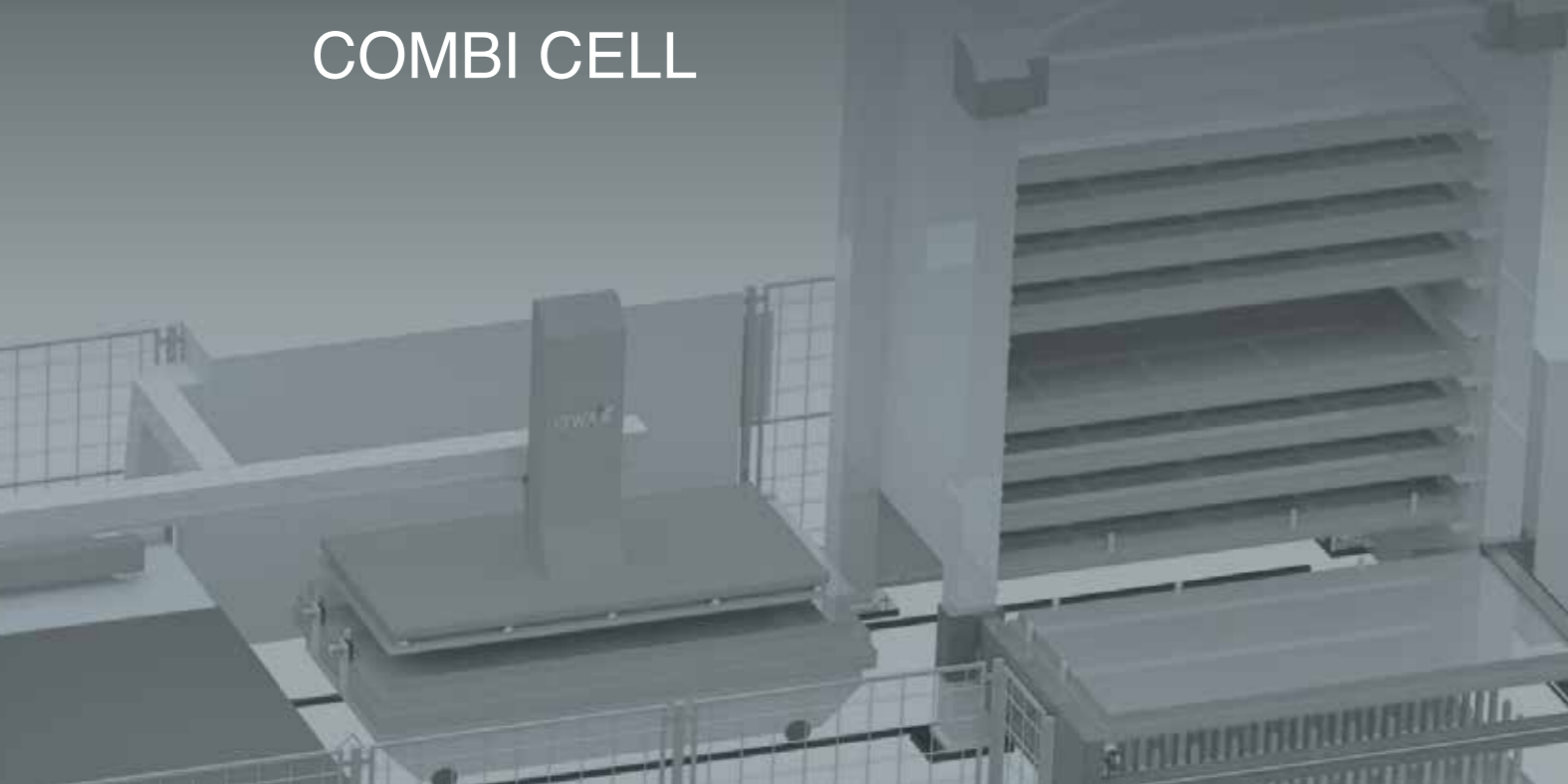

## Special automation cell for sheet metal punch and shear

The sheet metal punch and shear combi automated cell combines the punching and cutting processes and is responsible for rapid and high-quality processing and separation of workpieces and feeding them to a blanking table or stacking device for stacking. The sheet metal punch and shear combi automated cell is highly efficient, accurate and fast for many metal products industries with thin sheet, and has a popular with domestic and oversea market.

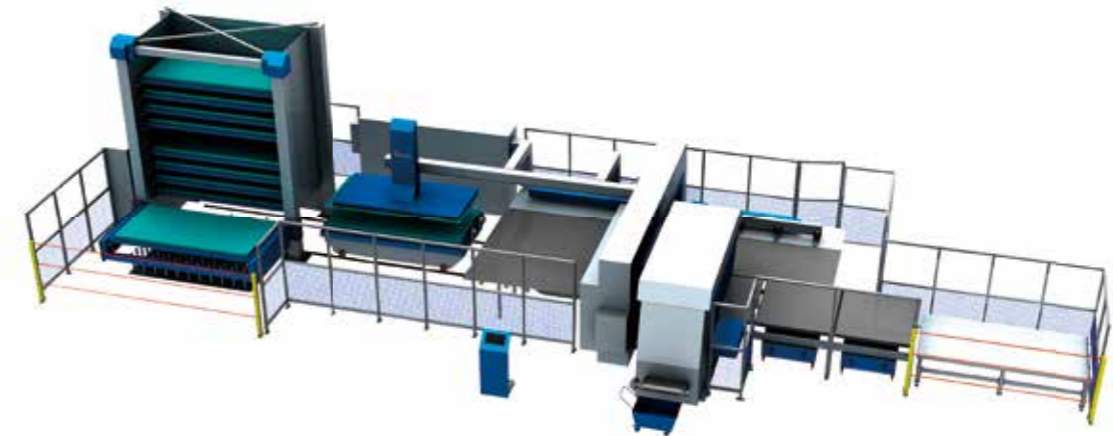

CNC punch and shear combi cell - solution two



CNC punch and shear combi cell - solution one

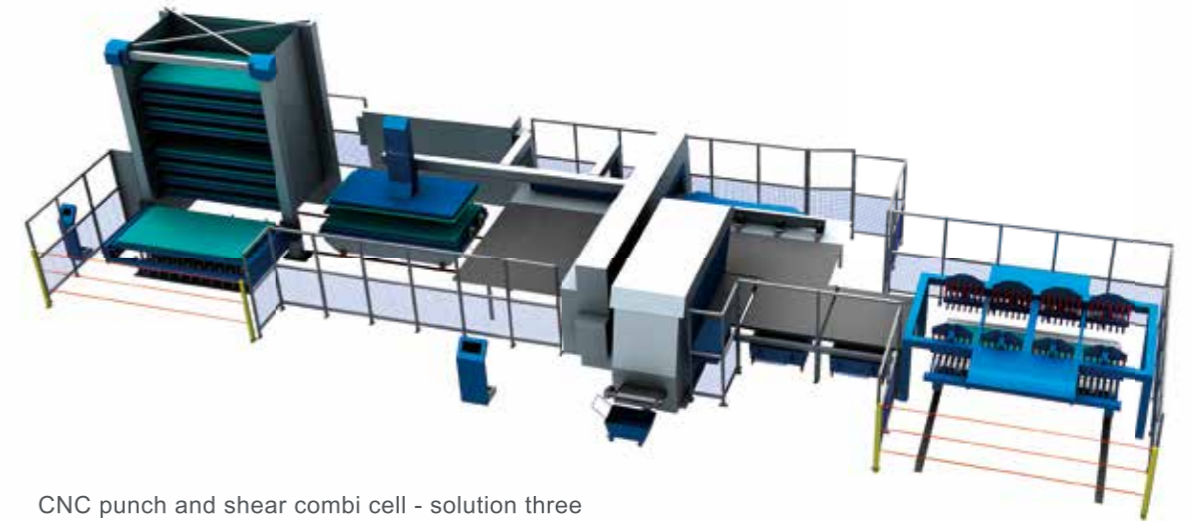

CNC punch and shear combi cell - solution three

## Specialized for sheet metal bending

Since 1977 Yawei has focused on pressbrake technology innovation and research, has accumulated a wealth of successful experience, serving all kinds of sheet metal processing industries with a broad customer base. Existing pressbrake series products and features are able to provide a variety of choices for you to achieve optimal bending process and solutions.

The existing series of bending machine products and features provide a wide range of options for you to achieve optimal bending processes and solutions.



PBH Series CNC Press brake



PBC CNC Press brake



PBE Series Mechanical Servo Drive Bending Machine



PBA Series CNC Press brake



2-PBH/PBA Series Tandem Large Tonnage Bending Machine

 CNC PRESS  
BRAKE

## CNC BENDING CELL

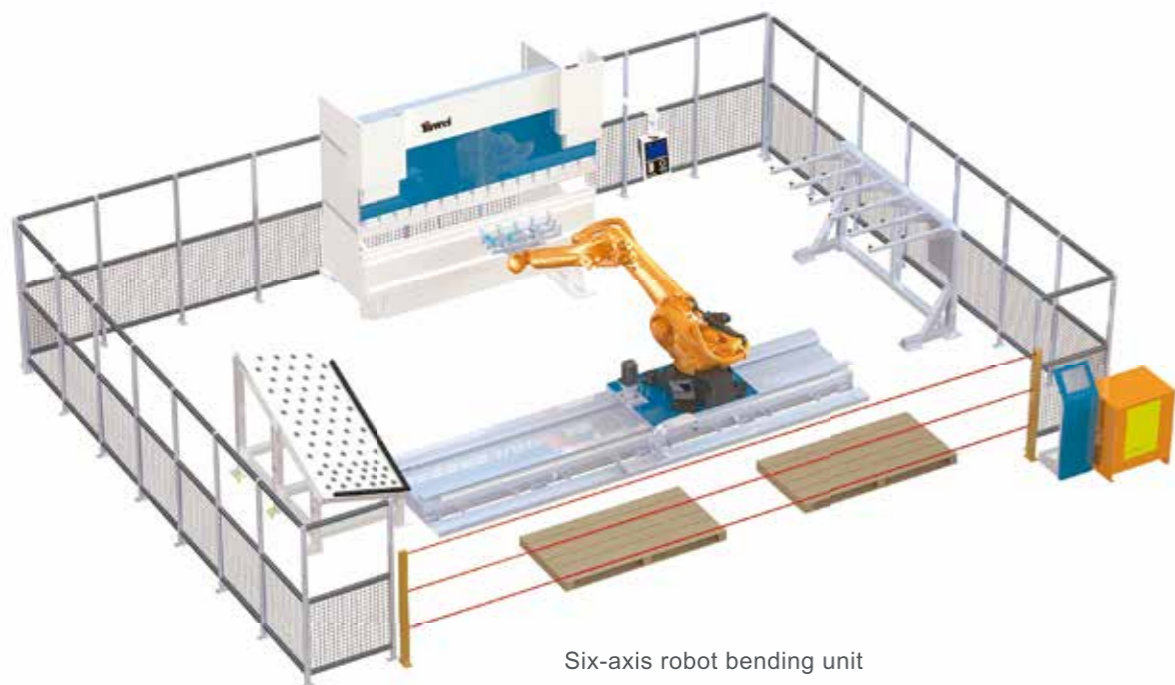

Six-axis robot bending unit

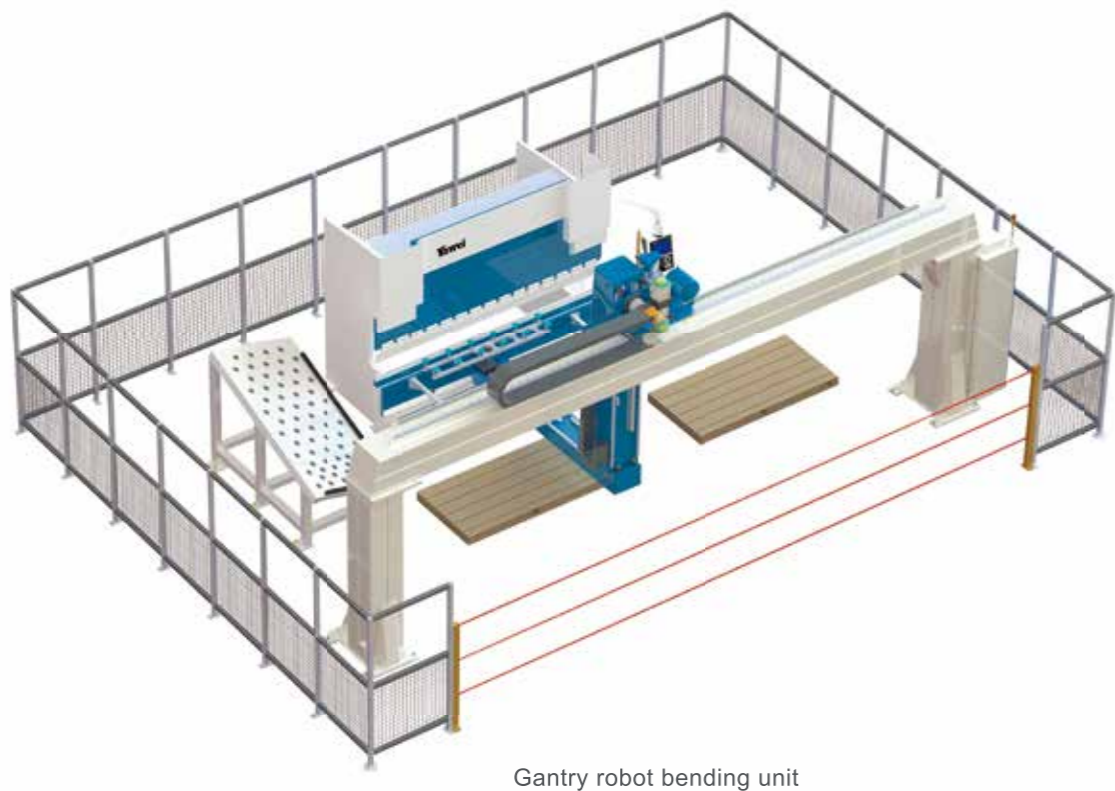

Gantry robot bending unit



TO BE THE WORLD'S LEADING HIGH-END EQUIPMENT  
AND SMART MANUFACTURING SOLUTION PROVIDER

Bending Unit (Live-action)

### Specialized for sheet metal bending automation

The robot bending unit mainly realizes that the robot replaces the manual grabbing of the plate, aligns the center and completes the bending with the press brake, and finally neatly stacks the workpieces. The bending of the robot can realize multi-edges bending and turn-over bending material. A robot can complete multiple processes and has a high space utilization rate.



## CNC PANEL BENDER

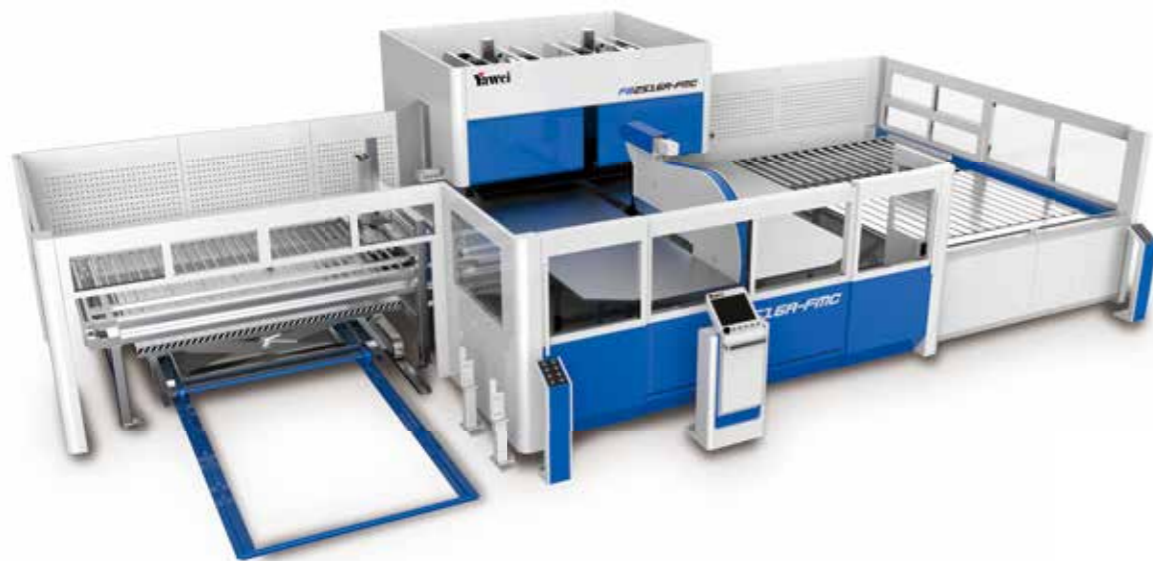

CNC PANEL BENDER

## High-end equipment for folding metal sheets

Compared with the traditional bending machine, CNC sheet metal panel bender is a new type of high-end sheet metal CNC folding equipment, high efficiency, high precision, good processing performance, high level of automation, which is the best choice for sheet metal bending and can be widely used in home appliances, elevators, cupboard, e-cabinet and other industries.

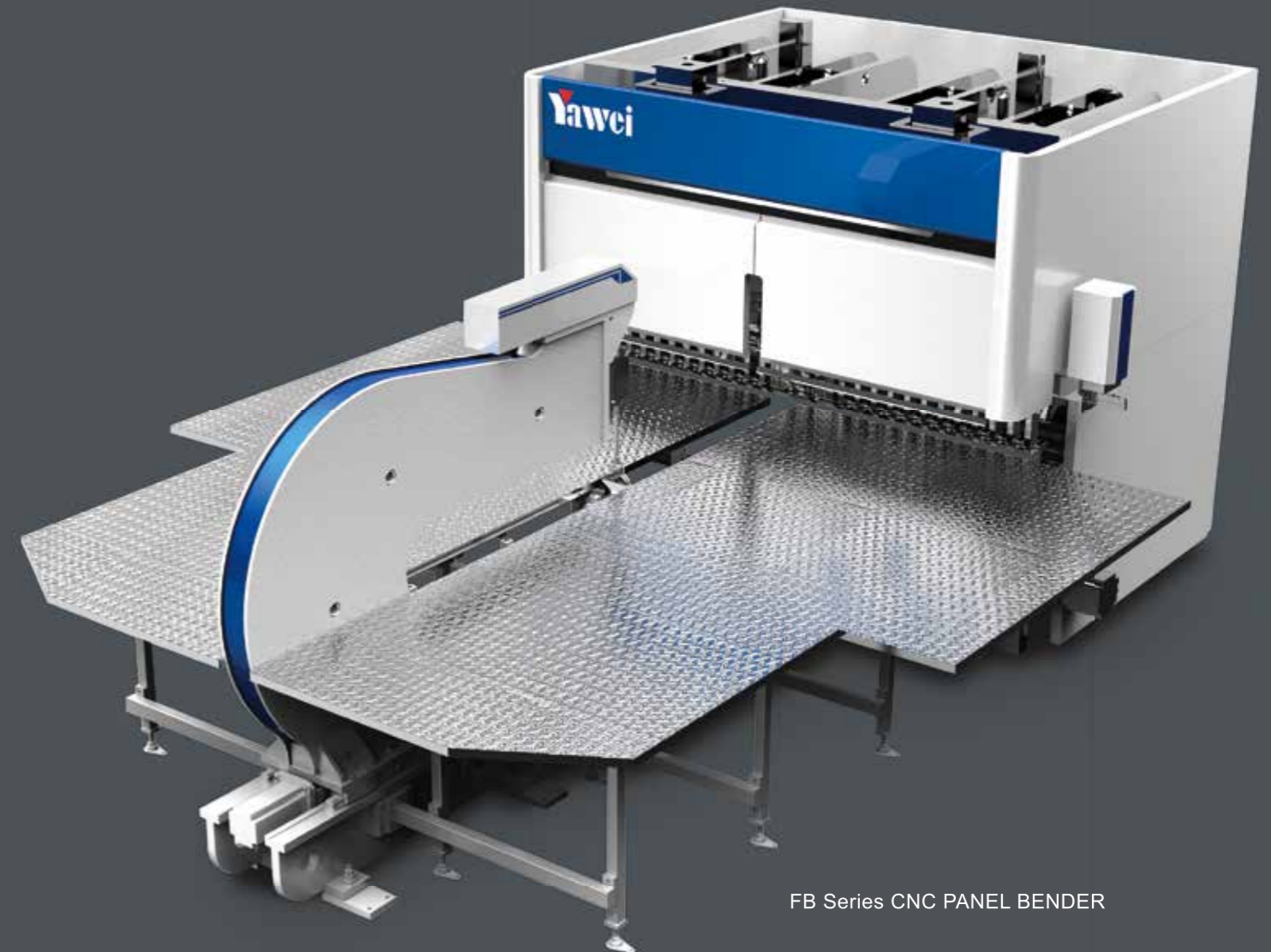

FB Series CNC PANEL BENDER



Complete automatic production line for sheet metal flexible manufacturing system

Automatic sheet metal processing system (Electric and ectrical power industrial)

## ⚙️ AUTOMATIC SHEET METAL PROCESSING SYSTEM

The sheet metal flexible manufacturing system is based on flexible manufacturing cells (punching units, punching and shearing units, bending units, etc.), equipped with a large-scale three-dimensional warehouse, automatic loading and unloading, sorting palletizing devices and other auxiliary devices,. The automatic control of each unit and the whole line is realized by the CNC system. The 24-hour unmanned production is no longer a dream.

The large material warehouse realizes the automatic input, output and storage of metal sheets and workpieces, the tedious and time-consuming material search is automatically completed by the system, the heavy manual loading and unloading of materials is replaced by the loading and unloading devices, the completed workpieces are not manually sorted and are automatically sorted, The system can do it for you. Not only save labor costs, but also increase equipment production efficiency.

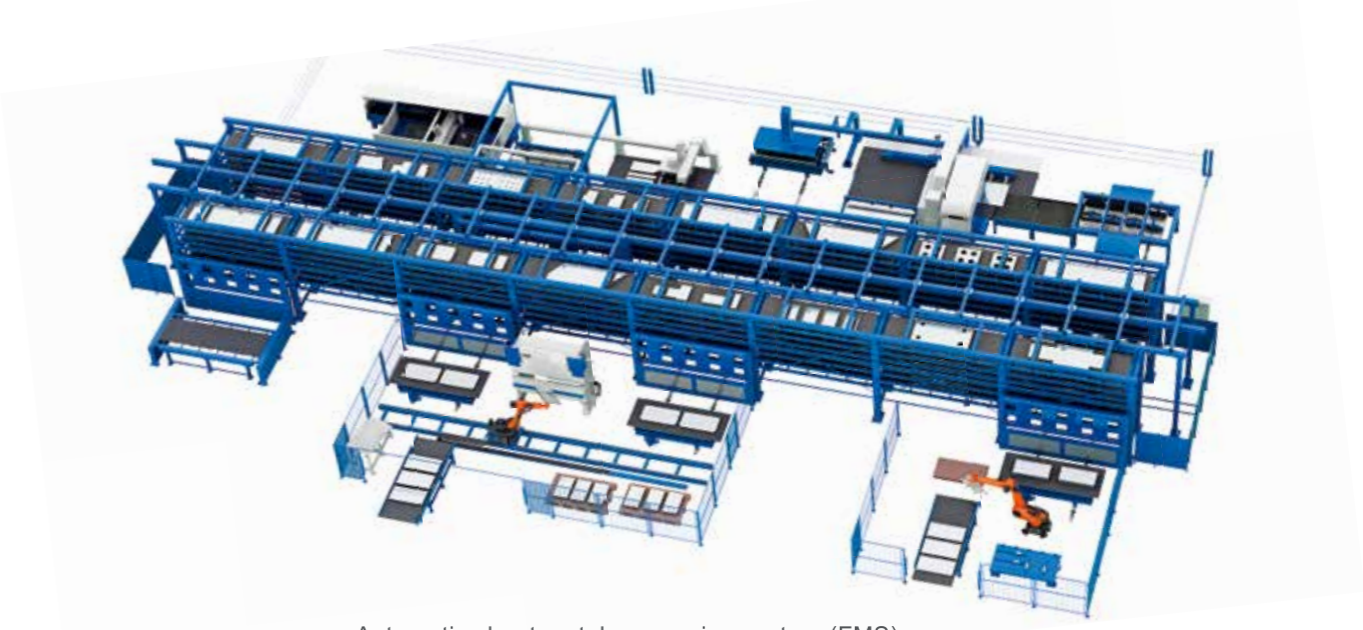

Automatic sheet metal processing system (FMS)



Automatic sheet metal processing system (Automobile Industry)



Automatic sheet metal processing system (Electric and electrical power industry)



Automatic sheet metal processing system (Elevator industry)

## AUTOMATIC SHEET METAL PROCESSING SYSTEM



## ⚙️ CUT TO LENGTH LINE, SLITTING LINE



Robot Setup for Slitting Line



Slitting Line



Cut to Length Line

Through reliable mechanical properties, the cut to length line can achieve high quality flatness of sheets, and the whole line adopts imported measuring system, which can realize precise length. Friendly HMI ensures convenient operation.

Each part of the slitting line adopts high precision processing technology to realize the accurate slitting function. The tension control of the whole line without scratch ensures that the coil material is neatly rewinding. The robot setup system realizes automatic setup knife, which can improve the efficiency by 20-40%.

# BLANKING LINE, CUTTING TO LENGTH LINE WITH OSCILLATING SHEAR

## Applied to the automobile industry

The blanking line and cut to length line with oscillating shear are mainly used for the flatness, stamping and shearing forming of metal sheet covering parts and other parts. It can meet the processing requirements of ultra-high strength automobile surface exterior plate, Thyssenkrupp standard FD plate and Baosteel standard O5 automobile exterior plate. It has reached the level of similar imported products in terms of performance index, automation class and product stability. In the past two years, it has been rapidly popularized and applied in the automobile industry, and has been strongly supported and recognized by the market.



Press blanking line



Cut to Length Line With Oscillating Shear

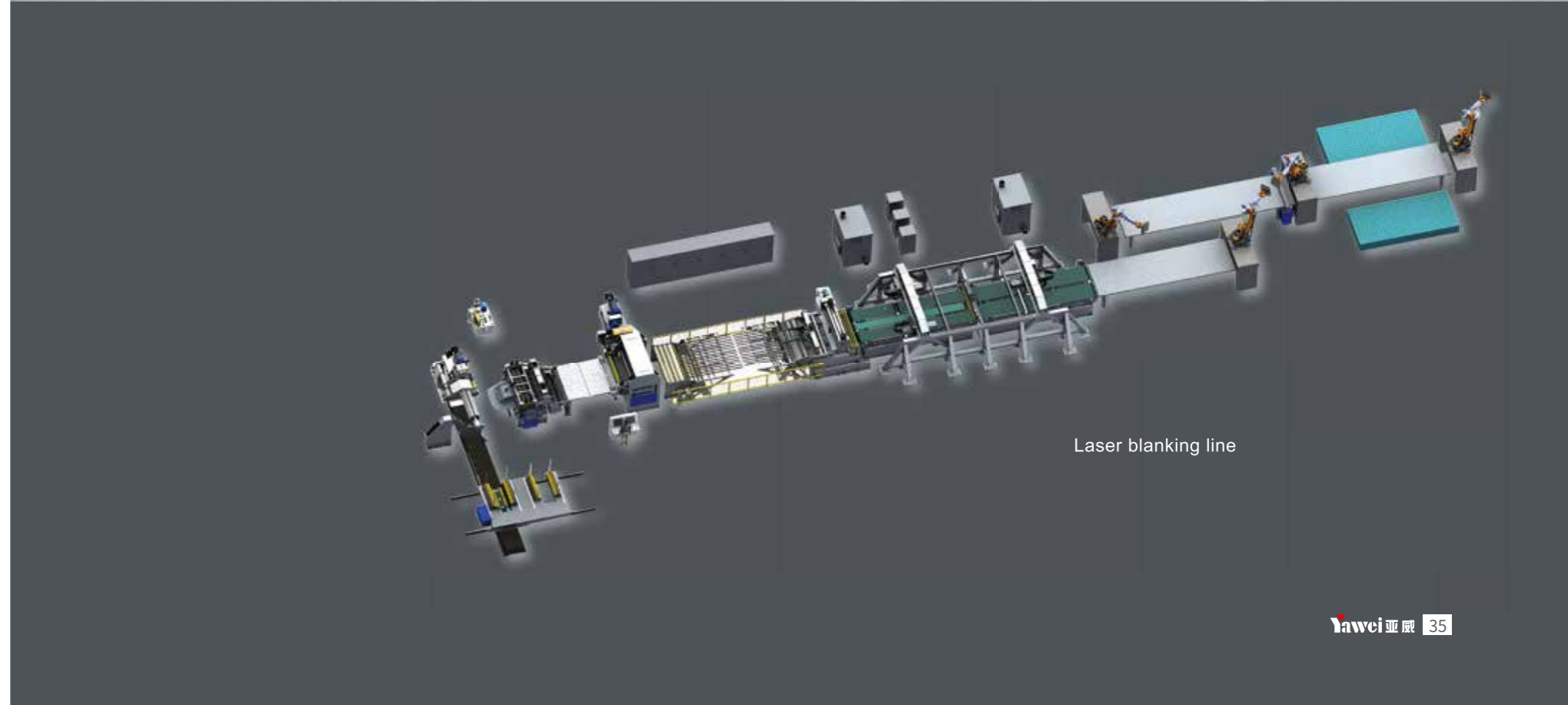

Laser blanking line

# ALUMINUM SHEET PROCESSING LINE



Aluminium ingot milling line

Complete set of equipment and special equipment for aluminum strip

Sino-Italian joint venture Yawei-SELEMA company is a professional aluminum strip equipment manufacturing company, is the first in China to manufacture high-end aluminum finishing equipment company, has pure Italian technology design, precision manufacturing and localization service.

Companies can provide with a package of non-ferrous metal plate finishing processing complete sets of solutions, in addition to manufacture high-end finishing equipment, can also provide old equipment upgrading and provide high quality service.

The company has provided high precision, high efficiency and intelligent complete set of aluminum strip finishing equipment for many high-end customers such as North China aluminum, Northeast China light alloy, ELVAL and L.AG. and etc.

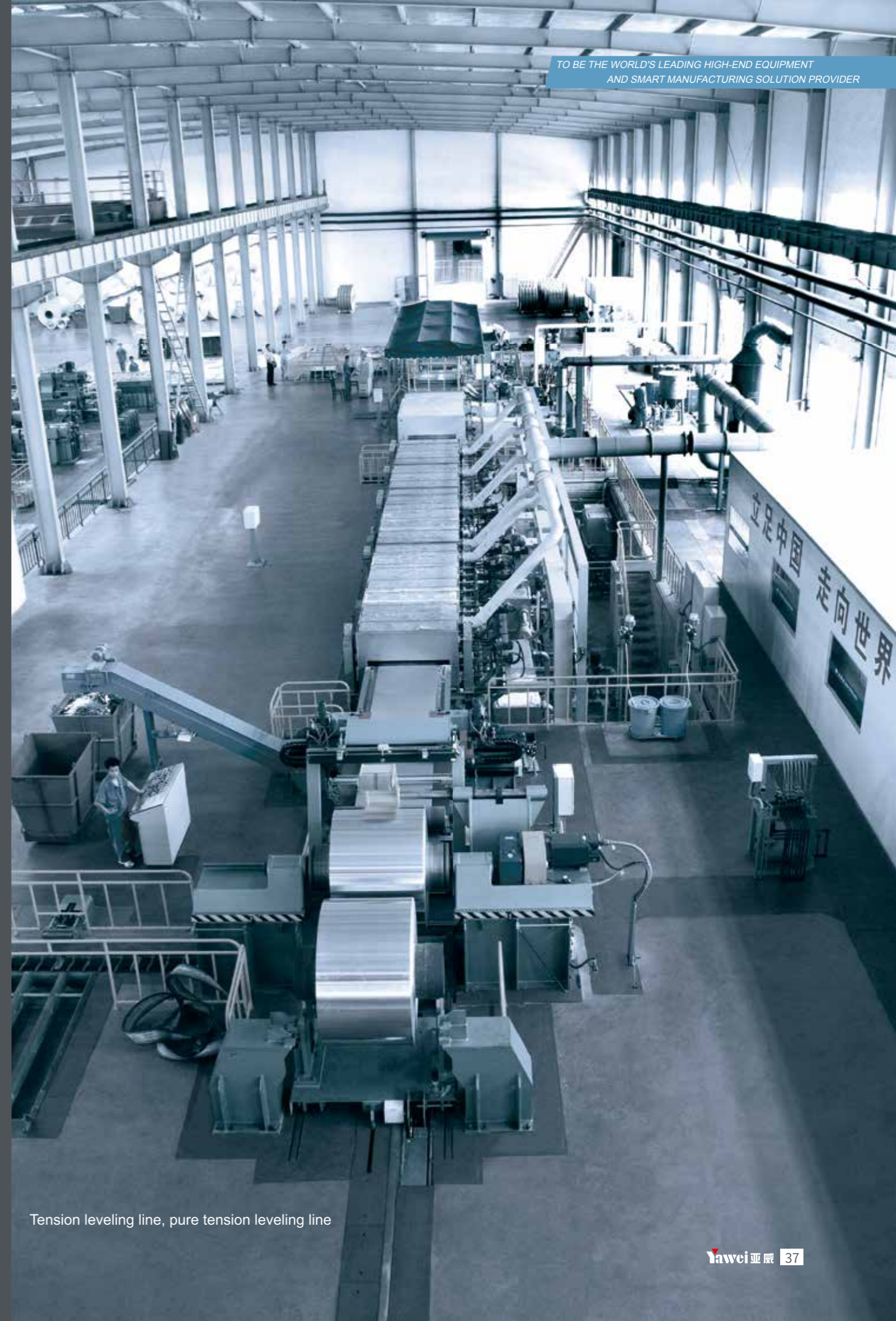

Tension leveling line, pure tension leveling line

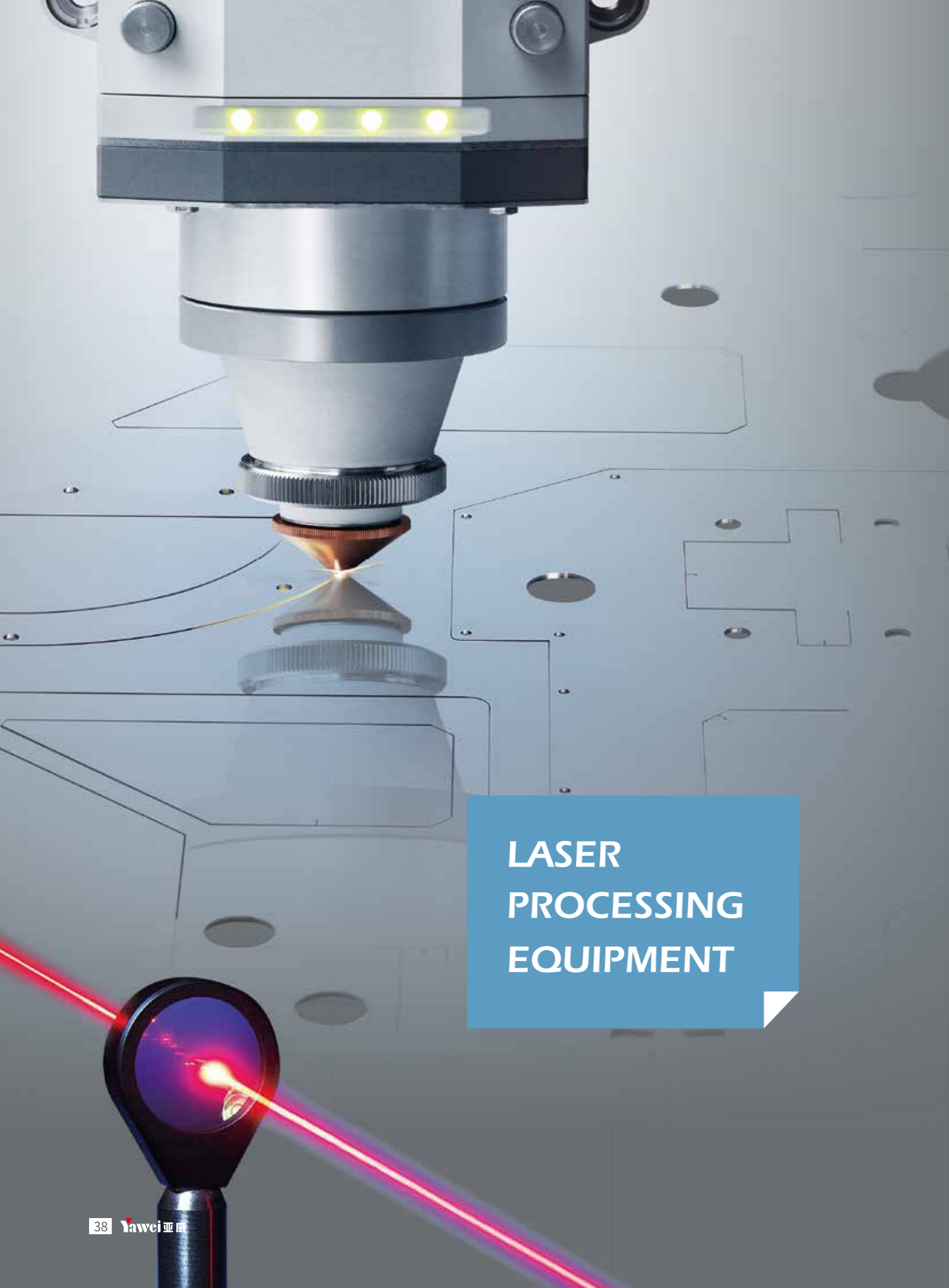

**LASER  
PROCESSING  
EQUIPMENT**





HLF Series high speed fiber laser cutting machine



HLE Series fiber laser cutting machine



CFFP Series fiber laser cutting machine



## 2D CNC LASER CUTTING MACHINE

Yawei 2D CNC laser cutting machine products enjoy a high reputation both at home and abroad due to its high cutting quality and high efficiency. It has doubled its sales volume for two consecutive years. At present, Yawei has already possessed an annual production capacity of more than 1,000 sets of high-quality laser processing equipment and automation systems, and the 8kW and 12kW ultra-high-power laser cutting machines have successfully delivered to customers and completed sales of multiple sets.

# 3D CNC LASER CUTTING MACHINE

Yawei 3D laser cutting system maintains a leading position in automotive OEM customers with excellent product quality. The latest 3D cutting system has successfully passed Toyota Motor customer acceptance and further expanded its market share among automotive OEMs.



3D laser cutting machine (Automobile industry)



3D laser cutting machine (Automobile industry)



3D laser cutting machine (Automobile industry)



HLTD Series 3D 5-Axis Laser Cutting Machine

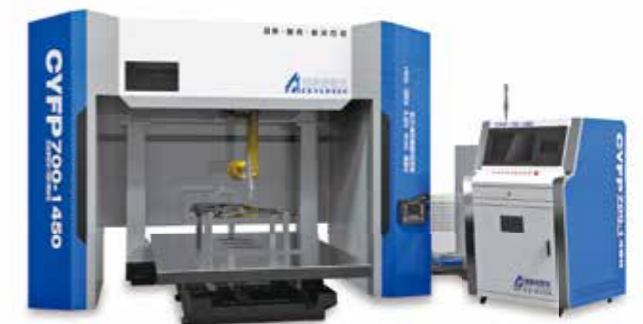

CYFP Series 3D Fiber Laser Cutting Machine



Thermoformed steel, profiled pipe, non-metal 3D cutting system

## ⚙️ LASER CUTTING CELL & SYSTEM

The laser cutting unit uses an automatic three-dimensional warehouse, loading, unloading, and stacking devices to replace the automatic loading and unloading of plates and automatic stacking. Yawei laser flexible processing units have been successfully delivered multiple customers, helping customers improve production efficiency and reduce labor cost.

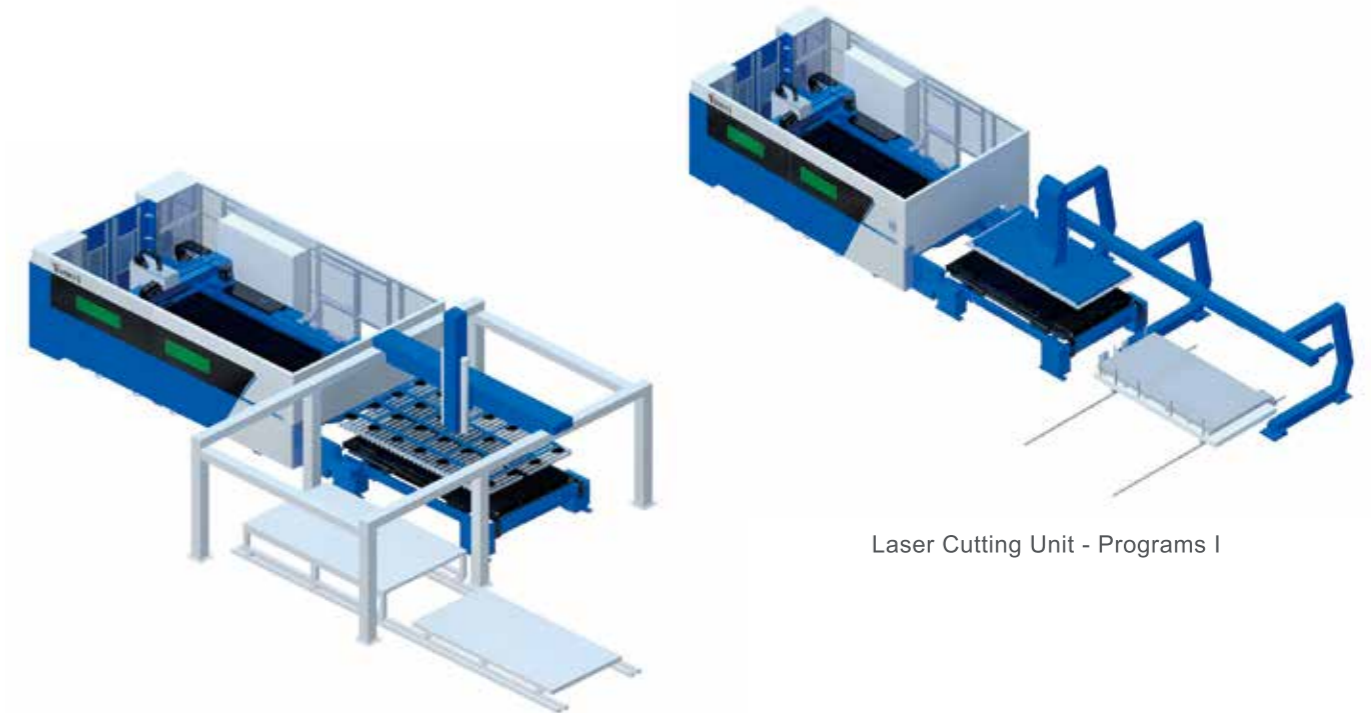

Laser Cutting Unit - Programs I

Laser Cutting Unit - Programs II

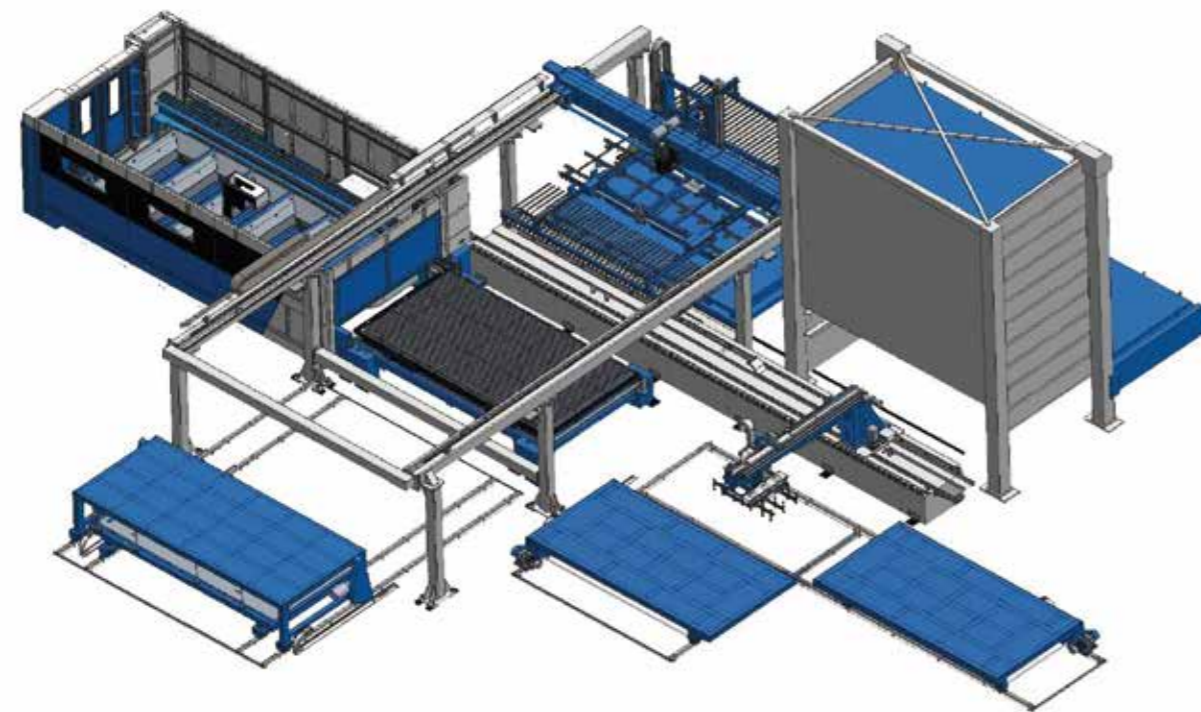

Laser Cutting Unit - Programs III

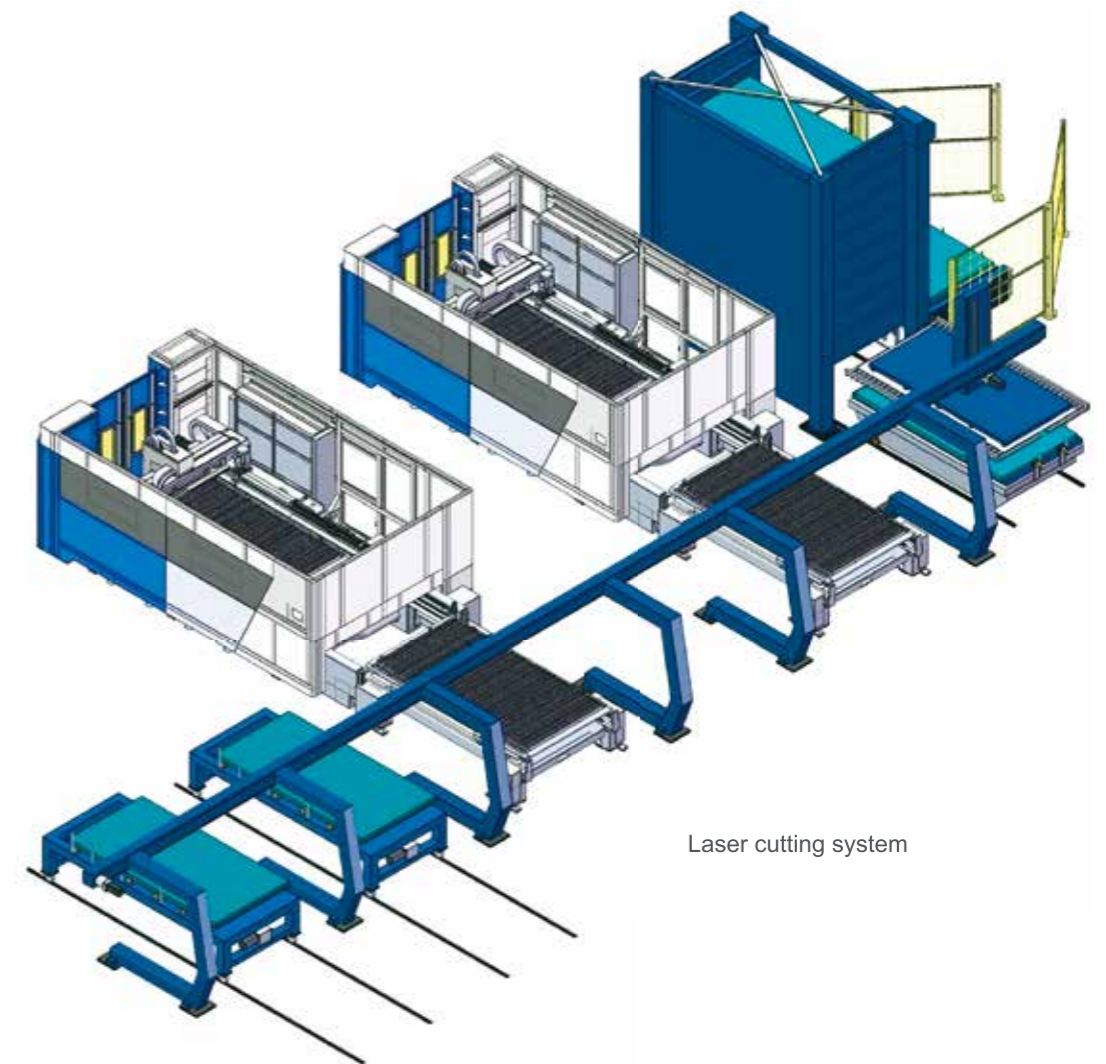

Laser cutting system

## CNC LASER TUBE CUTTING MACHINE

Yawei independently developed CNC laser cutting machine can be used for round tubes, rectangular tubes, special tubes, etc.

Mainly used in fitness equipment, agricultural machinery, engineering machinery and other fields.





## ⚙️ LASER WELDING EQUIPMENT

Yawei is able to provide whole laser welding solutions for the industries such like sheet metal processing, automobiles, ships, aviation, elevators, etc.

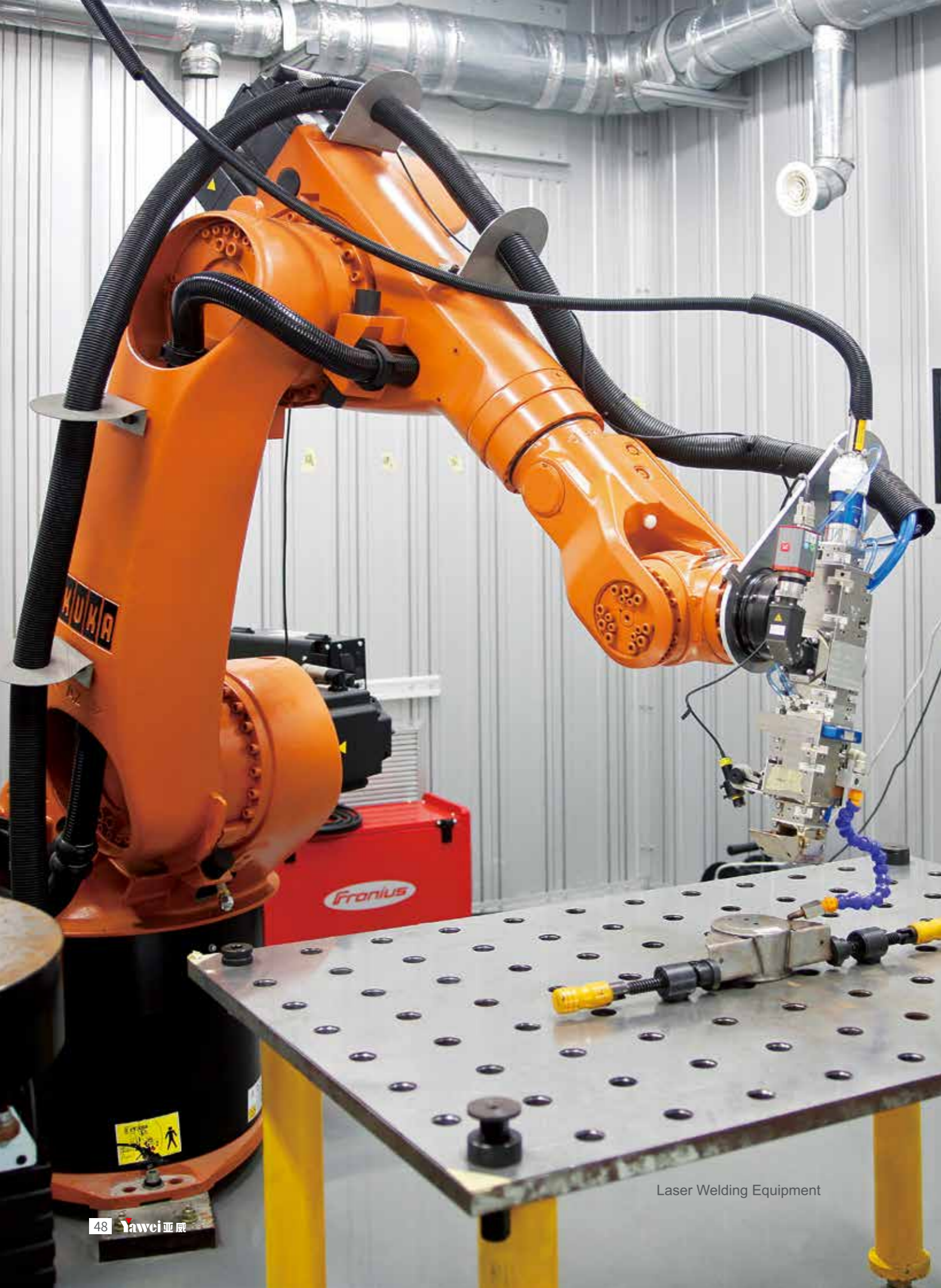

Laser Welding Equipment



# INTELLIGENT MANUFACTURING SOLUTION

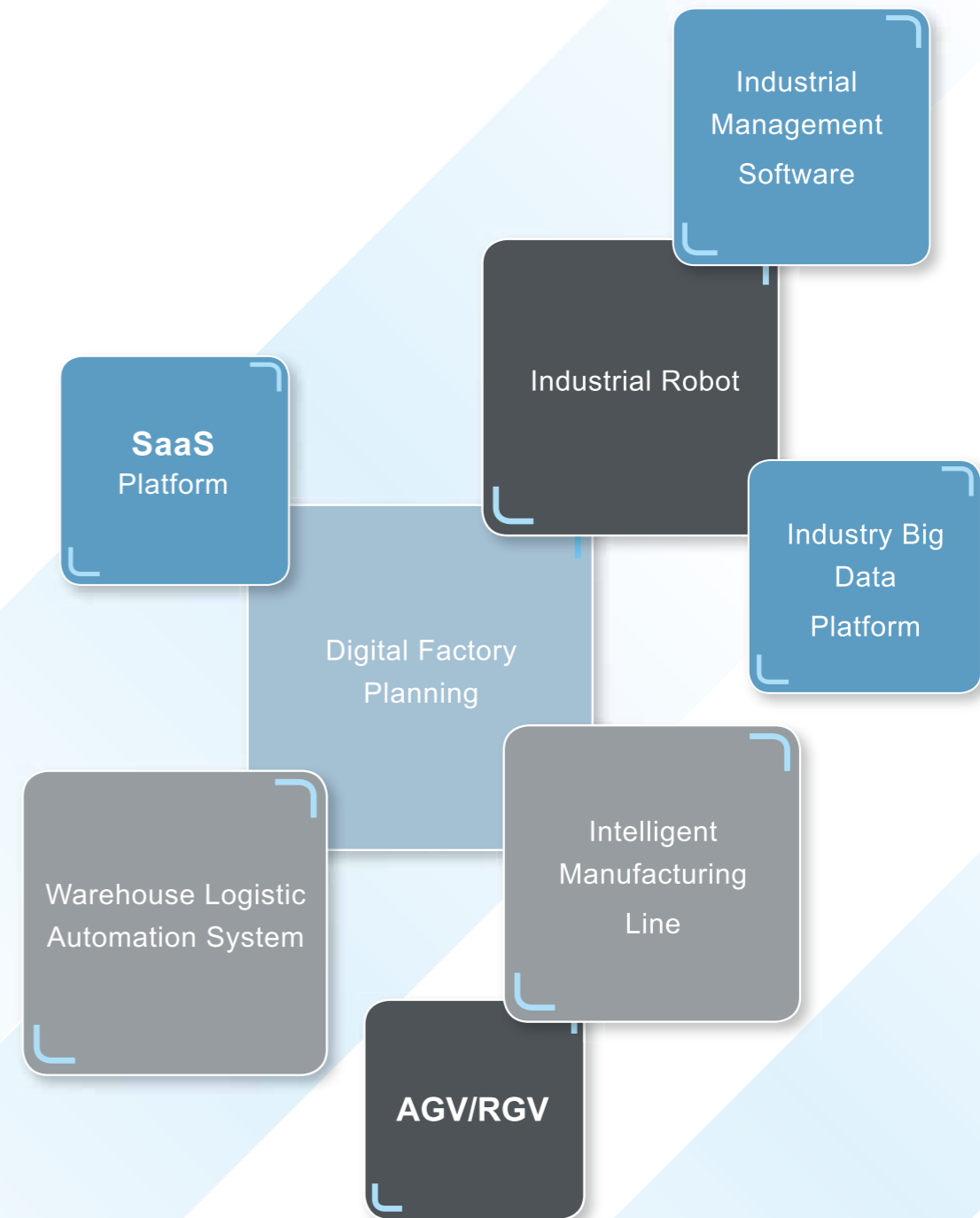



## INDUSTRIAL ROBOT

Relying on the joint venture robot subsidiary with KUKA, Yawei can provide linear and horizontal multi-joint robot bodies and industrial solutions based on industrial robots. Based on linear and horizontal multi-joint robots, Yawei has successfully provided intelligent manufacturing services for companies such as Jinggong Group and BORGWARD Group AG.



- YRL Series Single Gantry Linear Robot
- YRLP Series Dual Gantry Linear Robot
- YRLV Series Ground Rail Additional Axis
- YRLV Series Gantry Additional Axis
- YRC Series Robot Additional Axis
- YRH Series Horizontal Multi-joints Robot
- YRLVS Series Welding Automation Switching System
- YRBR Series Gantry Bending Robot

# WAREHOUSE LOGISTICS AUTOMATION SYSTEM

Thanks to YAWEI's intelligent automatic logistics solution, discrete manufacturing companies can make full use of the Internet technology and Industry 4.0 , create 3D automation warehouses, intelligent path planning, automatic AGV distribution, and upgrade the traditional factory logistics of the manufacturing industry to intelligent automatic logistics.



- Connect ERP and MES, combine MRP to realize the automatic request and distribution for material
- In the limited area , make use of the height, realize the 3D storage of material and automatic in-out of storage
- Rise up the utilization rate and cycle efficiency of in-out storage, realize the high efficient warehouse management
- AGV path planning, realize the fast and reasonable material transfer
- Roller liner, lift and AGV, realize the material transfer in multiple levels of space

## Customer case

YAWEI helped Kunshan Huguang Electrical, Ltd. and Shanghai Mitsubishi Elevator Co., Ltd. to build an intelligent logistics system to realize the interoperability of information ,automatic production and logistics.closely link up the logistics process needs like automatic 3D warehouses, roller lines, automatic logistics equipment like AGVs and material in-out of storage, product packing,and production,etc. Realize the automatic allocation of goods, automatic loading, first-in, first-out, automatic loading of work stations, automatic in-out of storage for semi-finished products and finished products, automatic product packing and whole process automated, planning AGV distribution routes automatically.



## Key Components

- YAWEI Ewms: 3D warehouse storage and logistics management
- YAWEI eWCS: 3D warehouse and logistics equipment control and management
- YAWEI Etns: AGV path planning and distribution management
- YAWEI eMES: Production material and transfer request
- YAWEI eMRP: In-out material and distribution request
- YAWEI eSCADA: Collect and analyze the logistics process data
- YAWEI eEDI: Interact and integrate the supply chain data
- YAWEI eSRM: Standardization management for purchasing material identification
- YAWEI eBMS: Management for logistics bar code
- YAWEI eALS: Management for logistics automatic transfer
- YAWEI eRSM: Robot stacking control and management



## INDUSTRIAL MANAGEMENT SOFTWARE

On the basis of automatic production lines, Yawei has introduced the core factory intelligent management software such as MES, WMS, and APS for customers to help customers achieve information-based transformation and upgrading.

- Gain end-to-end visibility covering the entire manufacturing operations process and master production processes
- Using real-time updated machine data feedback information to optimize production and improve equipment asset utilization
- Make full use of predictive analytics ,provide real-time cost structure analysis to increase cost efficiency
- Improve product quality and achieve quality traceability throughout the life cycle
- Integrate plant floor operations with core business processes

### Customer case

YAWEI helped Kunshan Huguang Electrical, Ltd and Ningbo Fuerda build an intelligent factory. All the machines and logistics equipment were connected to the sensors. All the hardware and software systems were connected, the hardware devices were networked, and the software information was integrated, realize real-time monitoring at the production site;Realize modularized production and logistics distribution based on customer EDI data exchange orders, to realize the automatic entry and exit of raw materials, toolings, semi-finished products and finished products.

### The key components

- YAWEI eMES: Manufacture excuting
- YAWEI eMRP: Manufacture Resource Plan
- YAWEI eAPS: The balance between APS and production capacity
- YAWEI eWMS: Storage and logistics management, realize the connection to automatic logistics storage
- YAWEI eSCADA: Collect and monitor the production data, realize the connection to automatic manufacturing equipment
- YAWEI eEDI: Interact and intergrate the supply chain data
- YAWEI eSRM: Supplier order information release and management
- YAWEI eMPM: Production performance management

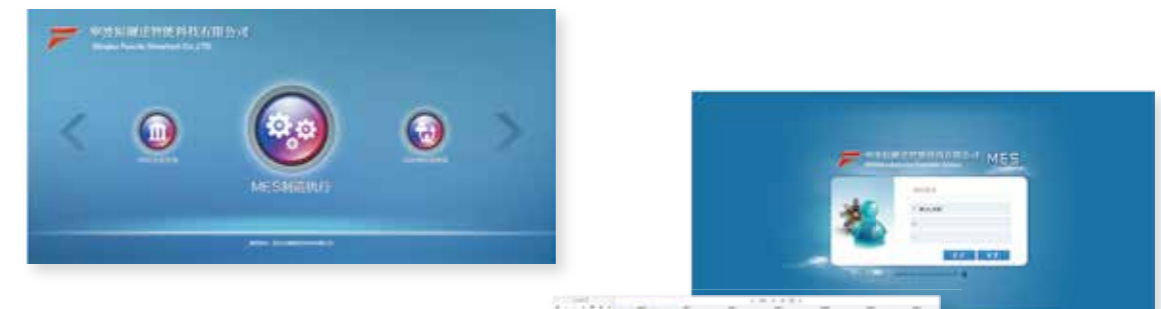

# ⚙️ SaaS PLATFORM

Based on mature industrial software R&D and implementation such as MES, APS, WMS, SCADA, and EAM.YAWEI accumulating experience and develop SaaS version of production management software, and through SaaS, a low-cost, fast-deployment, light-application online cloud service, YAWEI has rapidly explored a broader market for middle and small enterprises industrial software applications.

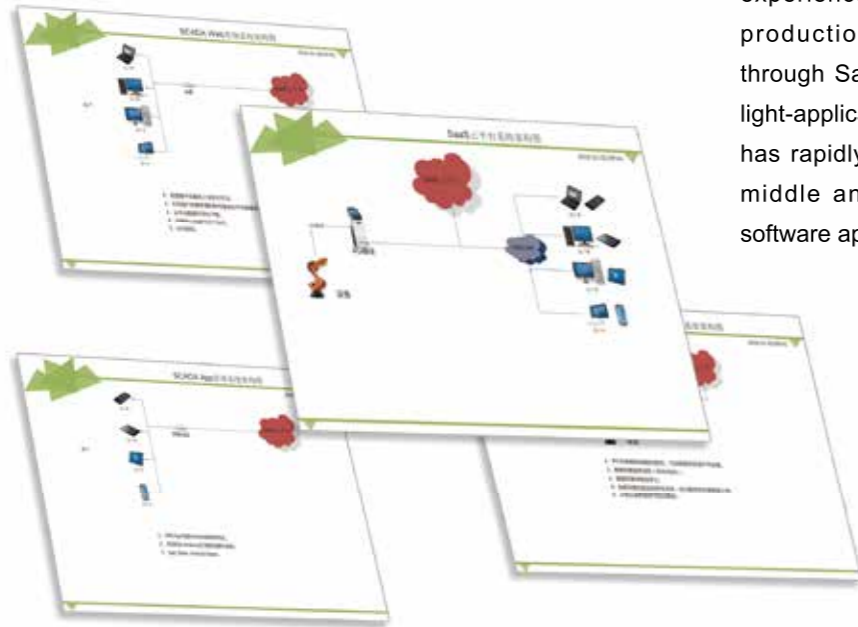

SCADA system structure schematic



SAAS-Login Interface



SAAS-Statistics Analysis



SaaS Platform Using Technology



SaaS Platform Technology Structure



YAWEI Cloud Manufacture Solution V1.1



# INDUSTRIAL BIG DATA PLATFORM

Through continued technological innovation and continuous accumulation of industry experience, Yawei Industrial Internet Big Data Platform increasingly becomes more intelligent in the industry. With the complete statistics, analysis, early warning and intelligent decision-making on data assets, YAWEI Can provide a complete solution for sheet metal, power and electronics, automotive and parts and elevator industries.

## Equipment interact information with MES



## Automatic Equipment Work Steps



## Schematic for Communication Between YAWEI MES and Machine Equipment



## Equipment Communication Method

### The NC Program Loading:

The NC program device interface of the YAWEI equipment CNC HMI, which can be used to conveniently load the NC program in two ways: A. Remotely load the NC from the shared NC program of the LAN network by sharing the TCP-IP file. program. B. Through the interface protocol, the MES dynamically stores the NC program on the local disk of the machine HMI.



### Real-time Information Acquisition:

Yawei machine tool can pass the specified process parameter information to the host computer system in a variety of ways. As shown in the figure on the right, using the TCP-IP method to achieve real-time parameter transfer to the upper machine system: Process parameter information includes, but is not limited to: system parameters, processing time, standby time, the current piece count of each part, load current, lubrication times, axis position, current alarm informatio.



### Data Exchange Sample:

Yawei machine tool equipped with real-time parameter data, processing operations instructions, can communicate in a variety of formats: XML, Excel, SQL Server, etc., in order to facilitate the upper computer system call.

## Data Demo



## ⚙️ DIGITALIZED FACTORY PLANNING

Relying on its own intelligent factory construction, YAWEI forms a leading manufacturing technology advantage and service capability in the discrete manufacturing industry. Provide customers with an intelligent factory integrated solution based on integrated software and hardware, Help downstream customers to achieve horizontal integration of various business processes from design, process, manufacture and quality, vertical integration from upstream suppliers, midstream plants to downstream customers, and end-to-end integration of the product's lifecycle process. Enhance the synergies among automation, information, intelligence and industry for customers, and help customers form an integrated manufacturing capacity with advanced levels of capacity supply, quality management and cost control.

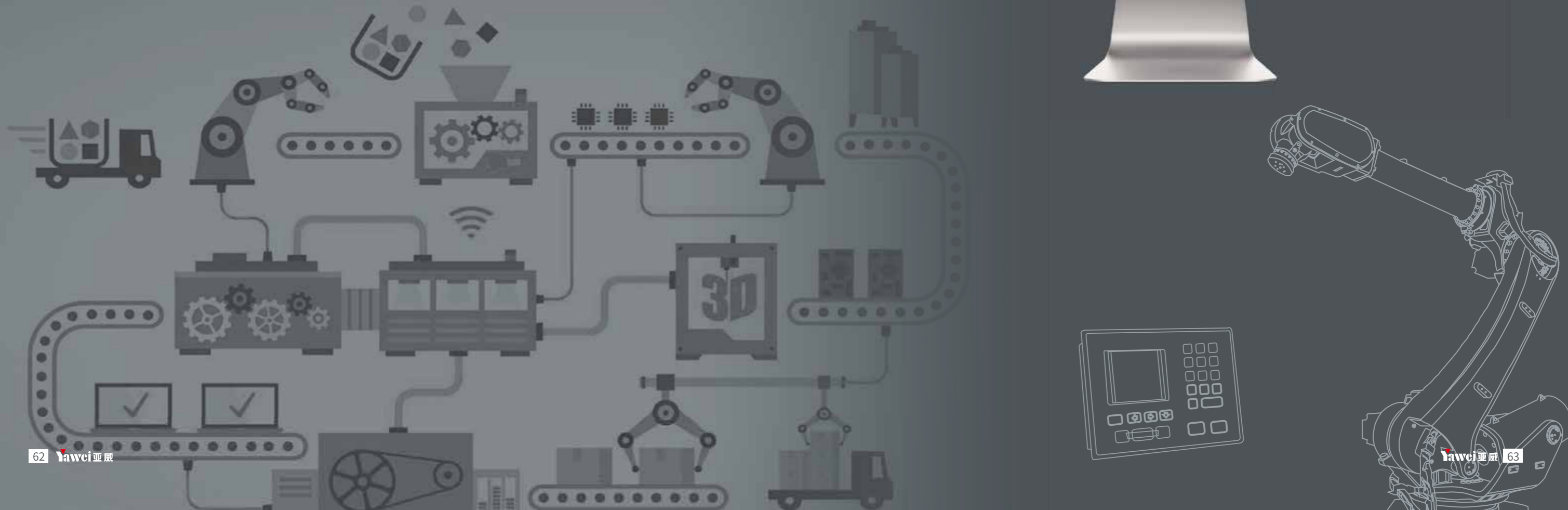



## 🔧 INTELLIGENT MANUFACTURING LINE

Yawei helps the customers of power electricity, professional sheet metal, auto parts, elevators, etc. to realize workshops and industrial automation, intelligent transformation and upgrading. Based on six-axis robots and linear robots ,YAWEI provides integrated applications solutions for customers in the automotive, new energy, and marine industries.



Yawei insists an innovation-driven, intelligent-transformation  
and green development course

Delicating to the construction of **"MADE IN CHINA 2025"**

and taking **"INDUSTRY 4.0"** as the goal

achieve "intelligent products", "intelligent equipments", "intelligent  
production", "intelligent management", to be the leading manufacturer  
in discrete manufacturing industry

## FUTURE DEVELOPMENT

China fully implements the "Made in China 2025" strategy of manufacturing power to accelerate the integration of the next generation of information technology and manufacturing into the main line, promote intelligent manufacturing as the main attack direction, accelerate the transformation and upgrading of manufacturing industries, and promote China's future remanufacturing industry to the developing direction of automation and intelligence, customization, and network.

Yawei adhering to the long-term goal of being a world-class high-end equipment and intelligent manufacturing solution supplier, insist the industry and capital two-wheel drive development strategy, constantly improving the industrial chain layout and improving differentiated competitive advantages around the three business segments. Focusing on key discrete manufacturing enterprises, an intelligent manufacturing solution of "Hard+Soft+Cloud+Integrated+Consulting Plan" will be formed, strive to become a new leader in intelligent manufacturing in dispersive manufacturing.



Stock Code 002559

# MORE INTELLIGENT MANUFACTURE MORE COMFORTABLE USE

## **JIANGSU YAWEI MACHINE TOOL CO., LTD.**

### **INTERNATIONAL**

XIANGCHENG INDUSTRIAL ZONE, HUANGHAI SOUTH ROAD

JIANGDU DIST. 225200 YANGZHOU, JIANGSU, CHINA

Sales hot line: +86-514-86880517 +86-514-86880518

Service phone: +86-514-86880517 +86-514-86880538

Part sales phone: +86-514-86519121

FAX: +86-514-86880521 +86-514-86882218

HTTP: [www.yawei.cc](http://www.yawei.cc)

Email: [sales2@yawei.cc](mailto:sales2@yawei.cc)

2018.06 As for the product improvements, this brochure is subject to the changes without notice.

